

DATE
22.12.2021

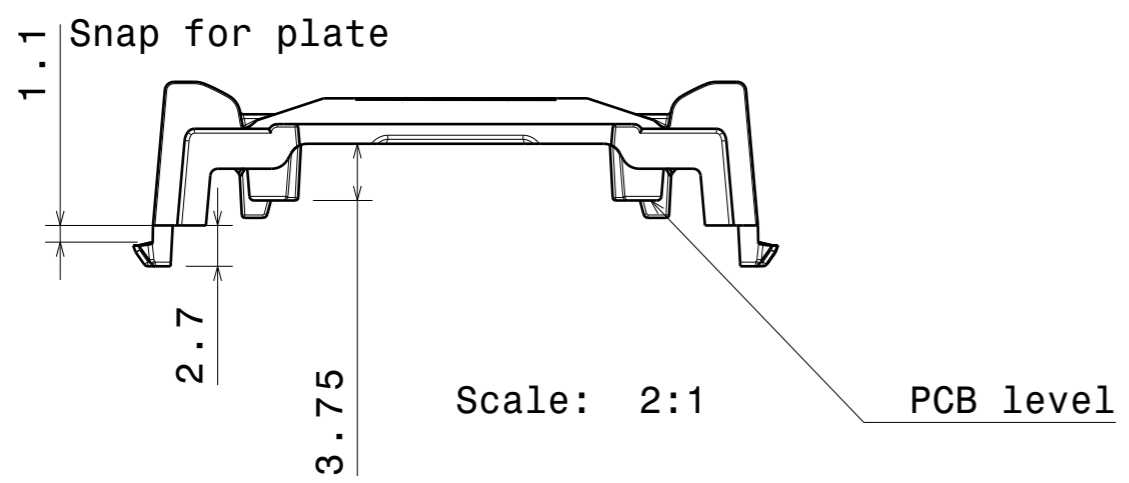
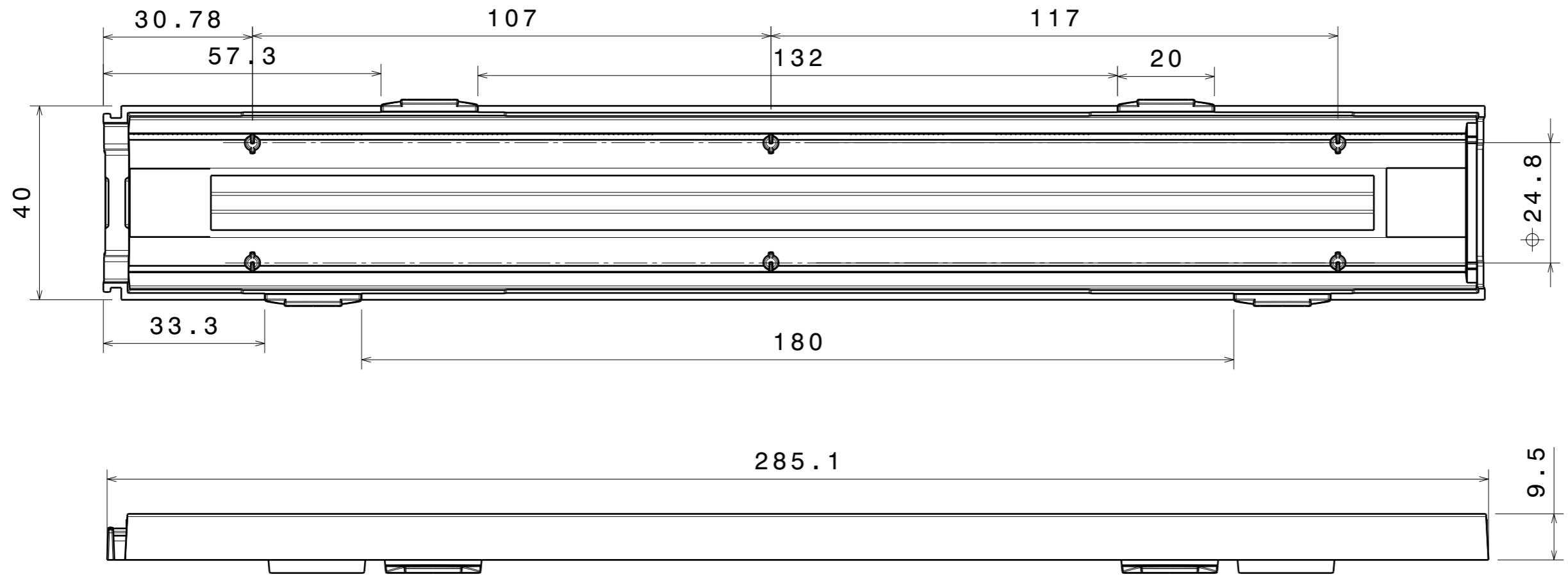

PART	TYPE	MATERIAL	COLOR / COATING
F15523_LINNEA-90		PC	clear

MECHANICAL DRAWING		LEDiL®
PRODUCT LINNEA		
Plastic moulding general tolerances according to DIN 16901-130 and applies if not otherwise shown in the drawing. Silicone moulding general tolerances according to ISO 3302-1 Class M3 and applies if not otherwise shown in the drawing.	FIRST ANGLE PROJECTION: 	This drawing is the property of LEDiL Oy. It may not be copied or otherwise distributed without prior written permission from LEDiL Oy.
SCALE 1:1	WEIGHT 33,72 g	A3 SHEET 1/2

Notes

	PCB or heatsink level.
	LED location
	Ensure LED fitting from a product specific 3D model available from www.ledil.com
	For more details about installation please see LEDiL Installation Guide on www.ledil.com